

LED NEON FLEX

NCR19 360° LED Neon Flex

Features

- Beam angle 360°, uniform light emission in all directions.
- Adopt high quality components design to achieve reliable performance
- Excellent flexibility for proper bending while easy to be modeling
- 24V DC low voltage, safe and reliable
- **No Cutting mark (Do not Cutting)**
- 5 year warranty

Specification

Item Code	Colour	CCT(K)/Wavelength	Luminous Flux(lm)	Efficacy(lm/W)
SA 1BJ	Warm white	3,000	1267	78.6
SA 1BK	Pure white	6,500	1270	74.8
SA 1BB	Red	620-625	387	24.2
SA 1BE	Blue	465-470	241	15.1
SA 1BD	Green	520-525	960	60
SA 1BC	Yellow	587-589.5	143	8.9
SA 1BG	Orange	600-605	322	20.1



Technical Characteristics

Power Consumption	16W/M
Voltage	DC24V
Current Dissipation	0.67A
Viewing Angle	360°
IP Rating	IP65
CRI (Ra)	80+
Dimmable	Dimmable
LED Quantity	336 pcs/M

Temperature Ranges

Operating temperature	-20~60°
Storage temperature	-20~70°

Warranty

Warranty	5 Years
----------	---------

Physical Characteristics

Dimensions(L*W*H)	5000*19mm
Weight	4700g

Dimensions (mm)

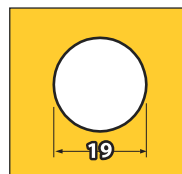

Profile Drawings

Sectional View

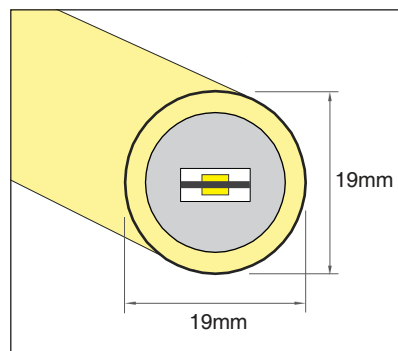

Minimum Bending Diameter

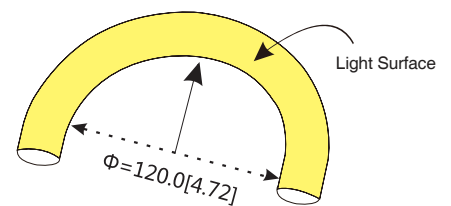

Bending Direction

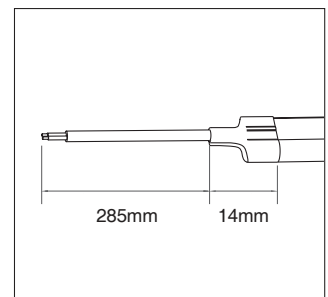
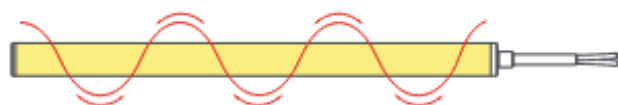

| Luminous Intensity Distribution Diagram

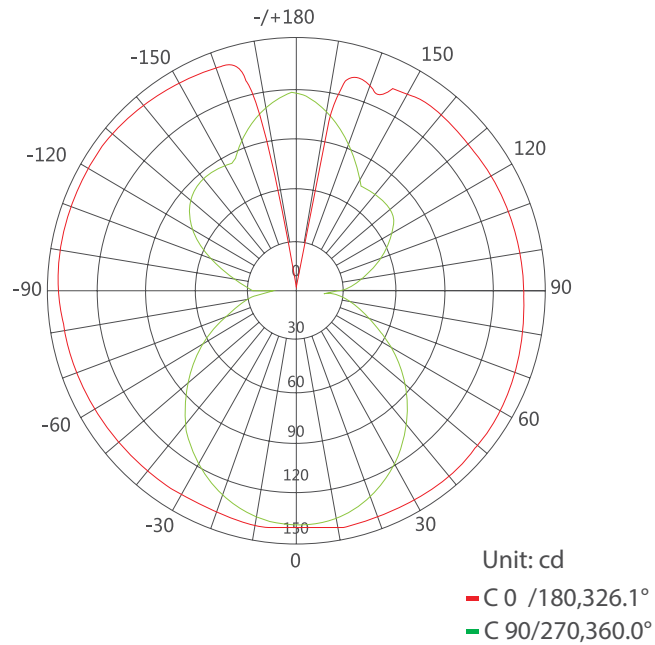

AVERAGE BEAM ANGLE (50%): 343.1°

| Average Illumination

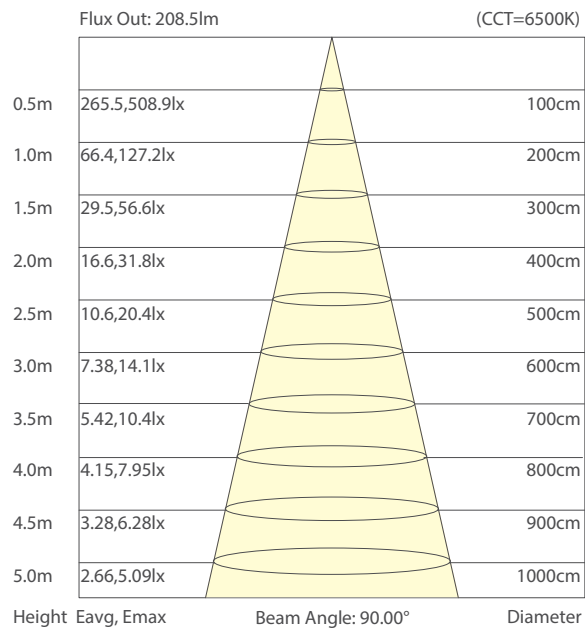

| Accessories

Endcap



With Hole
SA 95A1

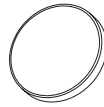

Without Hole
SA 95A2

Mount



Plastic Clip
SA 95A3

Cable

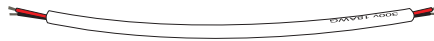

SA NCR19 White Jacket Cable
UL2464 20AWG Length 300mm cable
SA 95A6

Silicone Glue



SA NCR19 Silicone Glue
SA 95A5

Component Kit

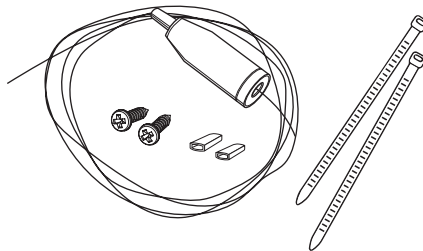

SA NCR19 Component Kit
Steel Wire, Crimping Tubes, Screw, Cable ties
SA 95A6